

RESIN PACKED BLDC MOTOR

- Dielectric Strength : AC 500V for 1 minute
- Insulation Resistance : Above 10M Ohms at 500 VDC
- Connection : Lead Wire (Three Wires)
- Motor Protection : Reverse Polarity & Locked Rotor
- Operating Temperature : - 20 to +70°C
- Noise dB(A) : Low Noise
- EMI : Low
- Signal Function : Available
- Life Expectancy : 70,000 hrs. @ 15°C
- Net Weight : 195 Grams



Note :-

- Shaft Length Can be made as per Customer's Requirement
- Connector with Wire also Available

Specification (With Load)

Model	Drawing No.	Part Code No.	Rotation	Air Direction	Voltage	Current	Input Power	Speed
REC					V	A	W	RPM
6120 A12		BLDC002	CW	-	12	0.23	2.76	2510
Impeller Ø 110 mm		PI008		Blow Out	-	-	-	-

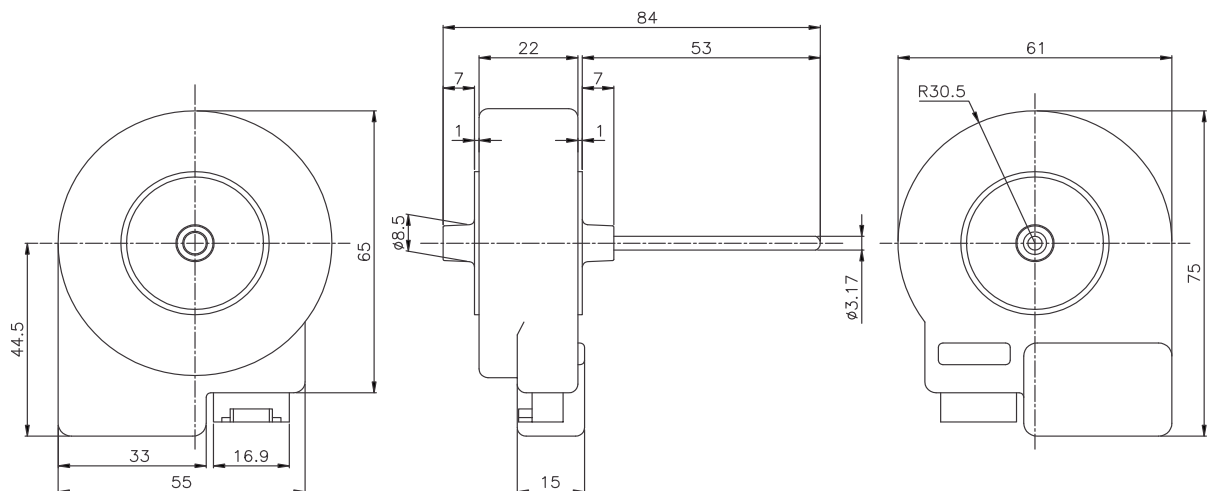

* Specifications Subject to Change Without Notice