

225 x 225 x 80 mm

- Motor Design : External Rotor with Capacitor Driven Motor
- Housing : Aluminium Die-cast
- Impellor : Metal
- Bearing : Ball Bearing
- Operating Voltage : 230V (185 - 245 VAC)
- Dielectric Strength : AC 1500V for 1 minute
- Insulation : Class F
- Insulation Resistance : Above 100M Ohms at 500 VDC
- Connection : Connector PA - 10
- Operating Temperature : - 20 to +80°C
- Net Weight : 2200 Grams (2.2 Kg)



Specification

Model No.	Code No.	Bearing	Voltage	Frequency	Current	Input Power	Speed	Air Flow	Static Pressure	Noise	Box Packing
REC			V	Hz	A	W	RPM	CFM	mm H ₂ O	dB(A)	Nos.
22580 B2 - MB	AC182	Ball	230	50	0.26	58	2650	540	14	59	5

Note : B = Ball Bearing 2 = 230 Volt MB = Metal Blade C = Connector

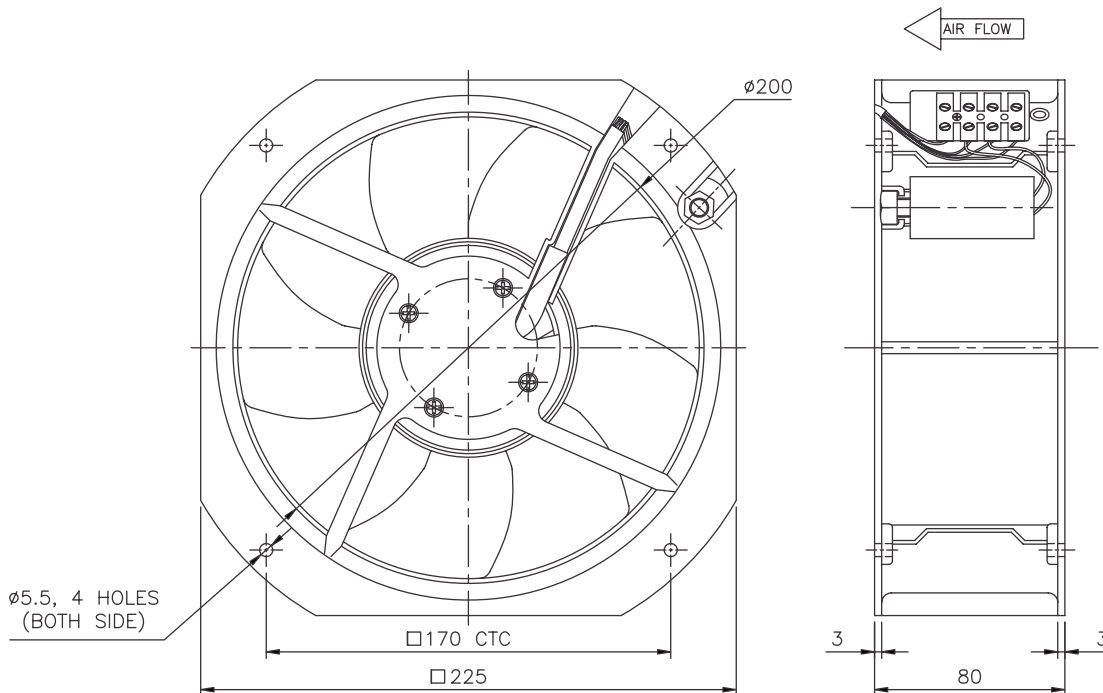

* Specifications Subject to Change Without Notice